

# DT04-3P-S-5/TXL

## Deutsch Connector – Connection Cable

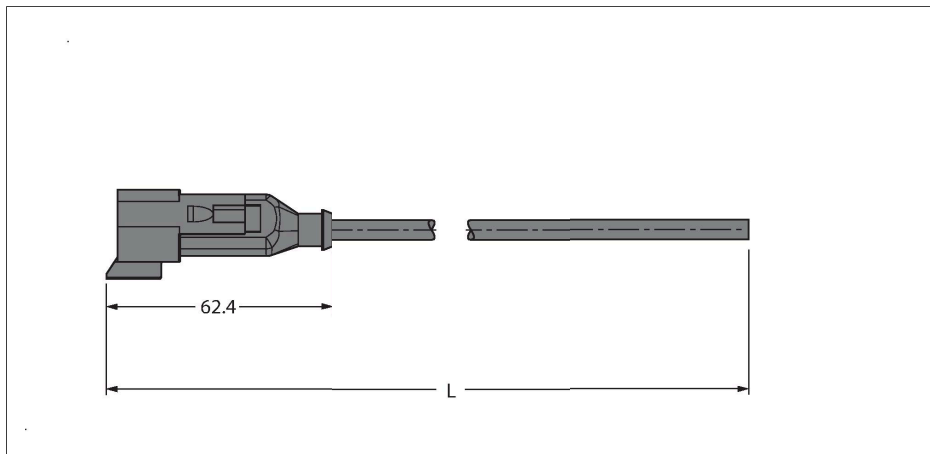

### Features



- Deutsch connector DT04, straight, 3-pin
- With protective circuitry (suppressor diode)
- With LED (yellow, 360° visible)
- Jacket material: TPE-U (PUR)
- Jacket color: black, similar to RAL 9005
- Qualified for drag chain use
- Flame-retardant acc. to cULus 20549
- Halogen-free acc. DIN VDE 0472 part 815
- Approval: cULus
- RoHS-compliant
- Protection classes IP67/IP69K
- Cable length: 5.0 m

### Contact assignment

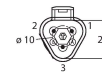

### Circuit Diagram

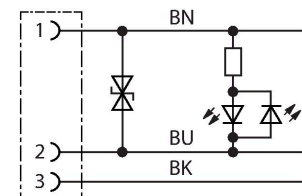

### Technical data

Type	DT04-3P-S-5/TXL
ID	100000428
Connector A	Male, Deutsch DT, Straight
Number of Pins	3
Contacts	Brass, CuZn, Nickel-plated
Contact carriers	Plastic, Thermoplast, Yellow
Connector body	Plastic, TPU, UL 94, Black
Protective component	Suppressor diode
Coupling nut/screw	Nickel-plated
Seal	Plastic, Silicone
Display operating voltage	LED, Yellow
Mechanical lifespan	> 100 Mating cycles
Protection class	IP67, IP69K, (plugged)
<b>Cable</b>	
Cable diameter	Ø 5.3 mm ±0.20
Cable length	5 m
Cable jacket	PUR, Black
Core insulation	PP
Core cross-section	3 x 0.75 mm <sup>2</sup>
Arrangement of strands	42 x 0.15 mm
Core colors	BN, BU, BK
<b>Electrical properties at +20 °C</b>	
Rated voltage	24 V
Test voltage	3000 V
Current	8 A
<b>Mechanical and chemical properties</b>	
Bending radius (stationary installation)	≥ 5 x Ø

## Technical data

Bending radius (flexible use)	$\geq 10 \times \varnothing$
Bending cycles	$\geq 4$ million
Admissible acceleration	max. 10 m/s <sup>2</sup>
Admissible traversing speed	3.33 m/s
Ambient temperature range (stationary)	-40 °C...+80 °C
Ambient temperature range (In motion)	-25 °C...+80 °C
Approvals	CE UKCA