

DT06-6S-A-5/TXL

Deutsch Connector – Connection Cable

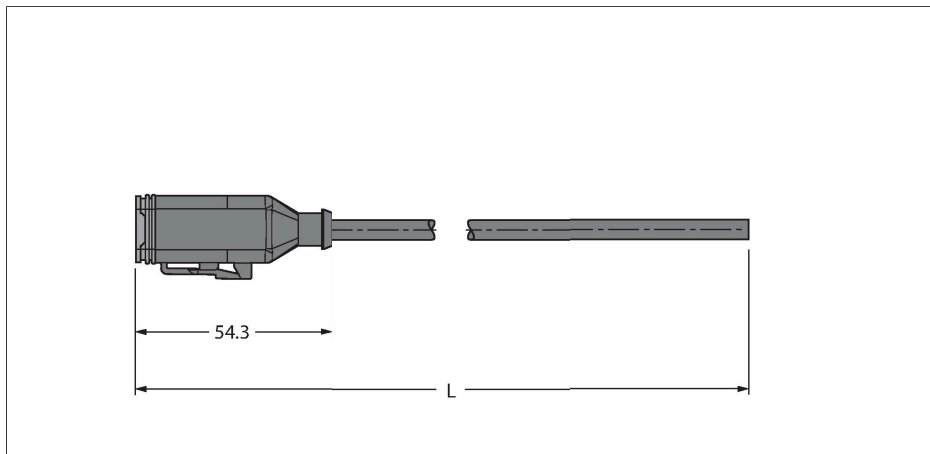

Features



- Deutsch connector DT06, straight, 6-pin
- Jacket material: TPE-U (PUR)
- Jacket color: black, similar to RAL 9005
- Qualified for drag chain use
- Flame-retardant acc. to cULus 20549
- Halogen-free acc. DIN VDE 0472 part 815
- Approval: cULus
- RoHS-compliant
- Protection classes IP67/IP69K
- Cable length: 5.0 m

Contact assignment

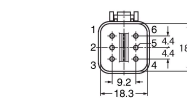

Circuit Diagram

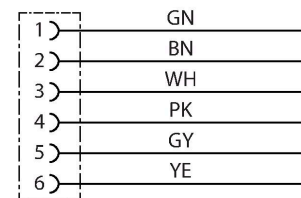

Technical data

Type	DT06-6S-A-5/TXL
ID	100000452
Connector A	Female, Deutsch DT, Straight
Number of Pins	6
Contacts	Brass, CuZn, Nickel-plated
Contact carriers	Plastic, Thermoplast, Green
Connector body	Plastic, TPU, UL 94, Black
Seal	Plastic, Silicone
Mechanical lifespan	> 100 Mating cycles
Protection class	IP67, IP69K, (plugged)
Cable	
Cable diameter	Ø 6.9 mm ±0.25
Cable length	5 m
Cable jacket	PUR, Black
Core insulation	PP
Core cross-section	6 x 0.75 mm ²
Arrangement of strands	42 x 0.15 mm
Core colors	GN, BN, WH, PK, GY, YE
Electrical properties at +20 °C	
Rated voltage	48 V _{AC} /60 V _{DC}
Test voltage	3000 V
Current	6 A
Mechanical and chemical properties	
Bending radius (flexible use)	≥ 12 x Ø
Bending cycles	≥ 4 million
Admissible acceleration	max. 10 m/s ²
Admissible traversing speed	1.67 m/s

Technical data

Ambient temperature range (stationary)	-40 °C...+80 °C
--	-----------------

Ambient temperature range (In motion)	-25 °C...+80 °C
---------------------------------------	-----------------

Approvals	CE UKCA
-----------	------------