

RJ45S-RJ45S-8814-3M

Industrial Ethernet Cable – Connection Cable

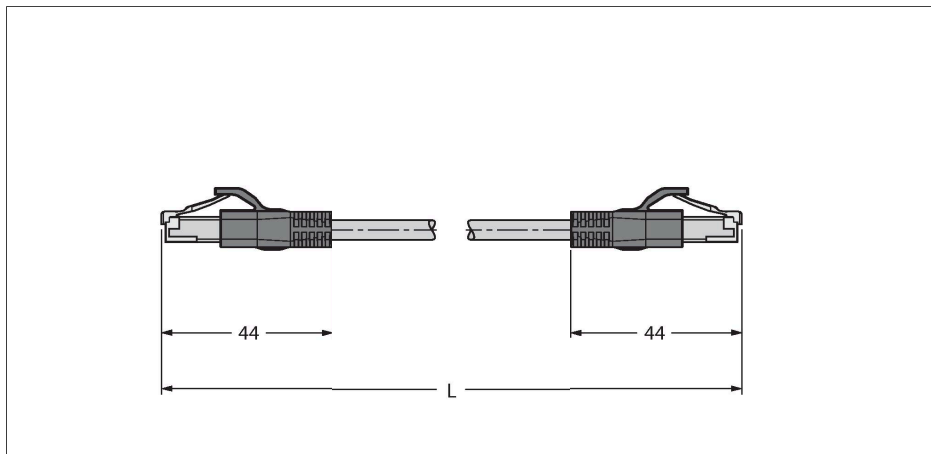

Features



- RJ45 male connector, straight, 8-pin
- RJ45 male connector, straight, 8-pin
- Ethernet cable: 8-pin, AWG 26, CAT 6A
- Jacket material: PUR
- Jacket color: green
- Jacket diameter: 6.7 mm
- Paired and shielded
- Oil resistant acc. to DIN EN 60811-404 (7 × 24 h/90 °C)
- UV resistant
- Flame retardant acc. to IEC 60332-2
- Approval: cULus
- RoHS compliant (2011/65/EC)
- Cable length: 3.0 m

Cable Cross-Section

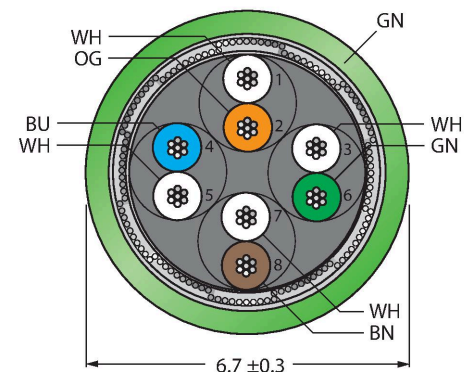

Circuit Diagram

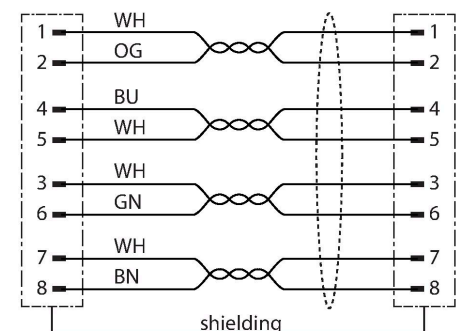

Technical data

Type	RJ45S-RJ45S-8814-3M
ID	100000696
Connector A	Male, RJ45, Straight
Number of Pins	8
Contacts	Metal, CuZn, Gold-plated
Contact carriers	Plastic, PC
Connector body	Plastic, TPU, Black
Mechanical lifespan	> 100 Mating cycles
Pollution degree	3/2
Protection class	IP20
Connector B	Male, RJ45, Straight
Number of pins	8
Contacts	Metal, CuZn, Gold-plated
Contact carriers	Plastic, PC
Connector body	Plastic, TPU, UL 94
Mechanical life	> 100 Mating cycles
Pollution degree	3/2
Protection class	IP20
Cable	
Network protocol	Ethernet
Cable diameter	Ø 6.7 mm ±0.30
Cable length	3 m
Cable jacket	PUR, Green
Shielding	yes
Core insulation	PE
Core cross-section	8 x 0.14 mm ²
Arrangement of strands	0.16 mm

Technical data

Core colors WH(OG)|OG;WH(GN)|GN;WH(BN)|
BN;WH(BU)|BU

Electrical properties at +20 °C

Rated voltage 48 V

Test voltage 700 V

Current 0.5 A

Mechanical and chemical properties

Bending radius (stationary installation) $\geq 5 \times \varnothing$

Bending radius (flexible use) $\geq 10 \times \varnothing$

Ambient temperature range (stationary) -40 °C...+80 °C

Ambient temperature range (In motion) -40 °C...+80 °C

Other Features

Qualified for drag chain use yes

PVC-free yes

UV resistance yes

Oil-resistant yes

Flame-retardant yes

Approvals cULus