

WKM52-10M

Power Supply Cable, PUR – Connection Cable

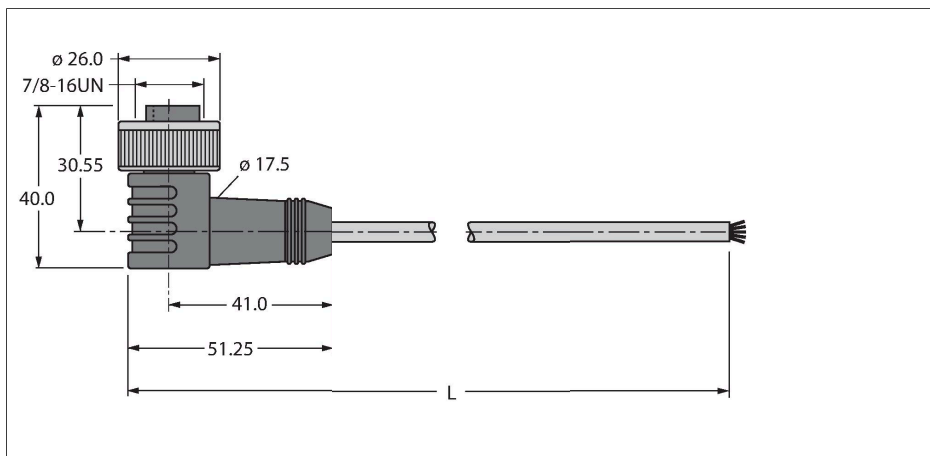

Features



- Power cable: 5 × 1.5 mm²
- Jacket material: PUR, color: gray
- Jacket diameter: 8.5 mm
- Suitable for drag chain use
- Oil resistant and flame retardant
- Halogen free
- Open end
- 7/8" female, angled
- Cable length: 10 m

Technical data

Type	WKM52-10M
ID	6604772
Connector A	Female, 7/8"-16 UN, Angled
Number of Pins	4+PE
Contacts	Metal, CuZn, Gold-plated
Contact carriers	Plastic, TPU, Black
Connector body	Plastic, TPU, Black
Coupling nut/screw	Brass, CuZn, Nickel-plated
Mechanical lifespan	> 100 Mating cycles
Pollution degree	3
Protection class	IP67, Only in screwed condition
Cable	
Cable diameter	Ø 8.5 mm ±0.30
Cable length	10 m
Cable jacket	PUR, Gray
Shielding	no
Core insulation	PP
Core cross-section	5 x 1.5 mm ²
Arrangement of strands	84 x 0.15 mm
Core cross-section	1.5 mm ²
Core colors	BN, WH, BU, BK, GNYE
Electrical properties at +20 °C	
Rated voltage	240 V
Test voltage	2000 V
Current	5.3 A
Mechanical and chemical properties	
Bending radius (flexible use)	≥ 10 x Ø

Cable Cross-Section

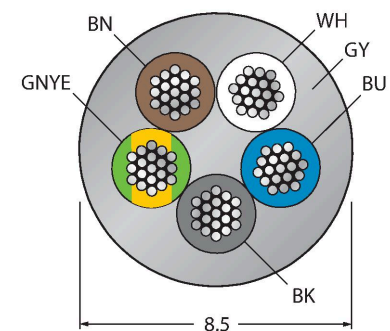

Contact assignment



Circuit Diagram



Technical data

Ambient temperature range (stationary)	-40 °C...+90 °C
Ambient temperature range (In motion)	0 °C...+90 °C
Ambient temperature during drag chain operation	0 °C...+90 °C
Other Features	
Qualified for drag chain use	yes
Halogen-free	yes
Oil-resistant	yes
Flame-retardant	yes
Approvals	CE UKCA