

WSC-WKC5701-6M

Bus Cable for CAN (DeviceNet, CANopen) – PUR Cable Jacket, Thin

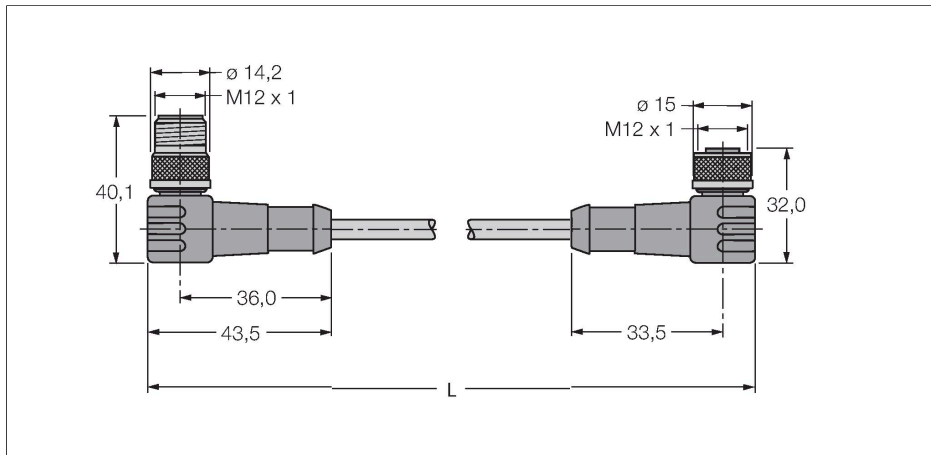

Features



- Sheathing material: PUR
- Jacket color: Anthracite
- Power pair: AWG 2/22
- Data pair: AWG 2/24
- Oil-resistant acc. to VDE 0472, part 803
- Flame-retardant acc. to VDE 0472, part 804/B
- Halogen-free
- UL approval
- M12-female, angled, A-coded
- M12 male connector, angled, A-coded
- Cable length: 6.0 m

Technical data

Type	WSC-WKC5701-6M
ID	6604827
Connector A	Male, M12 × 1, Angled, A-coded
Number of Pins	5
Contacts	Metal, CuZn, Gold-plated
Contact carriers	Plastic, TPU, Black
Connector body	Plastic, TPU, Black
Coupling nut/screw	Brass, CuZn, Nickel-plated
Tightening torque (range)	0.8 ... 1 Nm (observe max. torque of mating connector!)
Mechanical lifespan	> 100 Mating cycles
Pollution degree	3
Protection class	IP67, Only in screwed condition
Connector B	Female, M12 × 1, Angled, A-coded
Number of pins	5
Contacts	Metal, CuZn, Gold-plated
Contact carriers	Plastic, TPU, Black
Connector body	Plastic, TPU, Black
Coupling nut/retaining screw	Brass, CuZn, Nickel-plated
Seal	Plastic, FPM/FKM
Tightening torque	0.8 ... 1 Nm (observe max. torque of mating connector!)
Mechanical life	> 100 Mating cycles
Pollution degree	3
Protection class	IP67, Only when screwed together

Cable Cross-Section

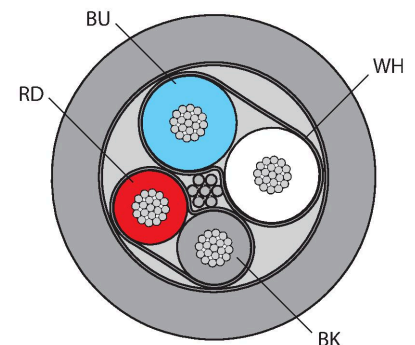

Contact assignment



Technical data

Cable	
Network protocol	DeviceNet CANopen, 5701
Cable diameter	Ø 6.7 mm
Cable length	6 m
Cable jacket	PUR, Anthracite
Shielding	yes
Core insulation	PE
Data cable cores	
Core cross-section	2 x 0.25 mm ²
Power cable cores	
Core cross-section	2x 0.34 mm ²
Core colors	Power: RD, BK, Data: WH, BU
Electrical properties at +20 °C	
Rated voltage	250 V
Current	4 A
DC resistance (loop)	82 Ω/km
Nom. impedance	120 Ω (1 MHz)
Nom. capacitance	37 pF/m
Mechanical and chemical properties	
Bending radius (stationary installation)	≥ 5 x Ø
Bending radius (flexible use)	≥ 10 x Ø
Ambient temperature range (stationary)	-40 °C...+80 °C
Ambient temperature range (In motion)	-25 °C...+60 °C
Other Features	
Qualified for drag chain use	yes
Halogen-free	yes
LABS free	yes
UV resistance	yes
Approvals	UL CSA