

VAS02-A80E-2/TEL

Valve connector A type – Connection Cable

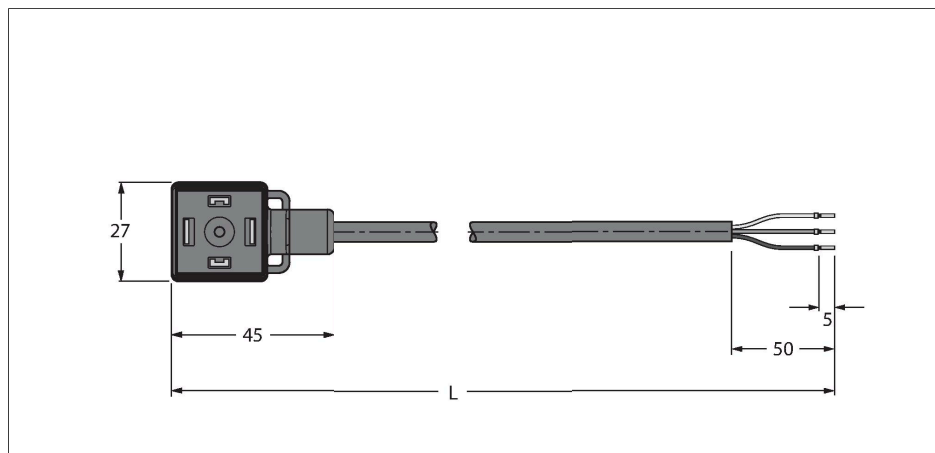

Features



- 2-pin + PE
- Design according to the DIN EN 175301-803
- RoHS-compliant
- Protection class: IP65, IP67, IP68
- Without protective circuitry
- Without LED
- Sheath material: PVC
- Sheath color: black
- Resistant to chemicals and oils
- Flame retardant
- Resistant to acids and alkaline solutions
- Resistant to microbes and hydrolysis
- LABS-free
- Cable length: 2.0 m

Technical data

Type	VAS02-A80E-2/TEL
ID	6606789
Connector A	Valve connector, Design A
Number of Pins	2+PE
Contacts	Metal, CuSn, Silver-plated
Contact carriers	Plastic, PA, Black
Connector body	Plastic, TPU, Black/Translucent
Protective component	without protective circuitry
Seal	Plastic, TPU
Mechanical lifespan	> 100 Mating cycles
Pollution degree	3
Protection class	IP65, IP67, IP68, (mounted)
Cable diameter	Ø 6.1 mm ±0.20
Cable length	2 m
Cable jacket	PVC, Black
Core insulation	PVC
Core cross-section	3 x 0.75 mm ²
Arrangement of strands	24 x 0.195 mm
Core colors	BN, BU, GNYE
Electrical properties at +20 °C	
Rated voltage	230 V
Test voltage	2000 V
Current	4 A
Insulation resistance	> 1 MΩ/km
Insulation resistance	≥ 10 ⁸ Ω
forward resistance	max. 57 Ω/km

Contact assignment

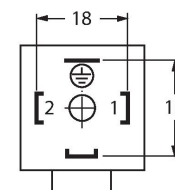

Circuit Diagram

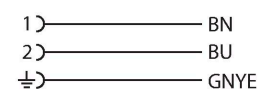

Technical data

Mechanical and chemical properties

Bending radius (stationary installation)	$\geq 5 \times \varnothing$
--	-----------------------------

Bending radius (flexible use)	$\geq 10 \times \varnothing$
-------------------------------	------------------------------

Ambient temperature range (stationary)	-40 °C...+105 °C
--	------------------

Ambient temperature range (In motion)	0 °C...+80 °C
---------------------------------------	---------------

Mounting screw	Brass, CuZn, nickel-plated
----------------	----------------------------

Approvals	CE UKCA
-----------	------------