

VAS22-S80E-0.3-WSC5.31T/TEL

– Extension Cable

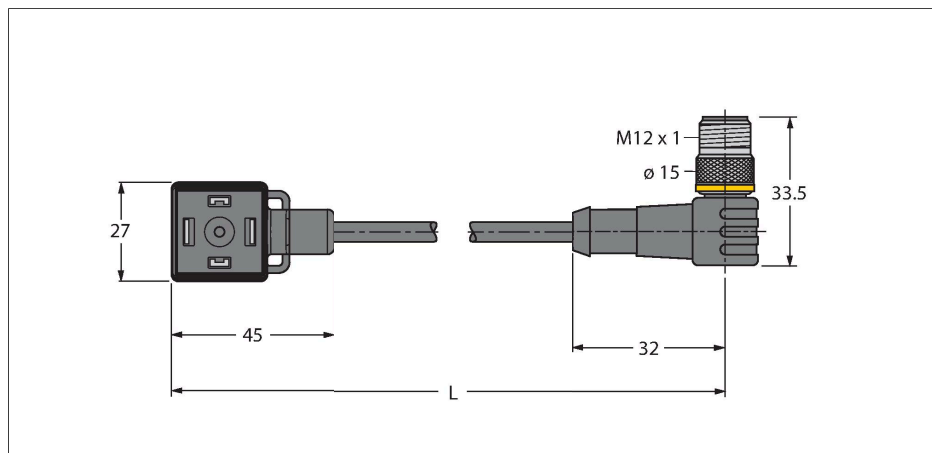

Features



- 2-pin + PE
- Design according to the DIN EN 175301-803
- RoHS-compliant
- Protection class: IP65, IP67, IP68
- Protective component: Transil diode
- M12 male, angled, 2-pin + PE
- Sheath material: PVC
- Sheath color: black
- Resistant to chemicals and oils
- Flame retardant
- Resistant to acids and alkaline solutions
- Resistant to microbes and hydrolysis
- LABS-free
- Cable length: 0.3 m

Technical data

Type	VAS22-S80E-0.3-WSC5.31T/TEL
ID	6606804
Number of Pins	2+PE, PE bridged
Protective component	Transil diode
Display switch state	LED, Yellow/Yellow
Protection class	IP65, IP67, IP68
Connector B	Male, M12 × 1, Angled
Number of pins	2+PE
Contacts	Metal, CuZn, Gold-plated
Contact carriers	Plastic, TPU, Black
Connector body	Plastic, TPU, Black
Coupling nut/retaining screw	Brass, CuZn, Nickel-plated
Tightening torque	0.8 ... 1 Nm
Mechanical life	> 100 Mating cycles
Pollution degree	3
Protection class	IP67, IP69K, Only when screwed together
Cable diameter	Ø 5.3 mm ±0.20
Cable length	0.3 m
Cable jacket	PVC, Black
Core insulation	PVC
Core cross-section	3 x 0.34 mm ²
Arrangement of strands	19 x 0.15 mm
Core colors	BN, BU, GNYE
Electrical properties at +20 °C	
Rated voltage	24 V
Test voltage	2000 V
Insulation resistance	> 1 MΩ/km

Contact assignment

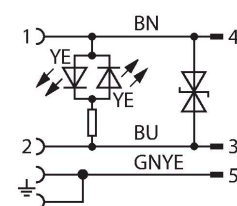
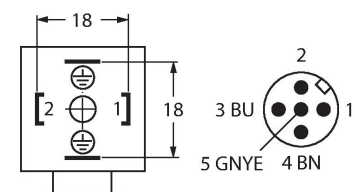

Technical data

forward resistance max. 57 Ω /km

Mechanical and chemical properties

Bending radius (stationary installation) $\geq 5 \times \varnothing$

Bending radius (flexible use) $\geq 10 \times \varnothing$

Ambient temperature range (stationary) -40 °C...+105 °C

Ambient temperature range (In motion) 0 °C...+80 °C

Approvals
CE
UKCA