

# VAS04-K81E-1.5-WSC5T/TEL

## Valve connector A type – Extension Cable

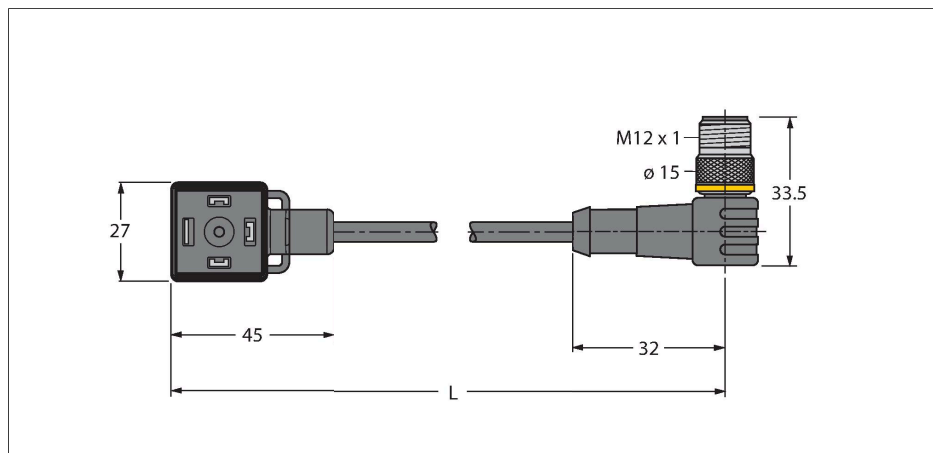

### Features



- 3-pin + PE / strand connection
- Design according to the DIN EN 175301-803
- RoHS-compliant
- Protection class: IP65, IP67, IP68
- Without protective circuitry
- M12 male, angled, 4-pin + PE
- Sheath material: PVC
- Sheath color: black
- Resistant to chemicals and oils
- Flame retardant
- Resistant to acids and alkaline solutions
- Resistant to microbes and hydrolysis
- LABS-free
- Cable length: 1.5 m

### Technical data

Type	VAS04-K81E-1.5-WSC5T/TEL
ID	6606813
Connector A	Valve connector, Design A
Number of Pins	3+PE
Contacts	Metal, CuSn, Silver-plated
Contact carriers	Plastic, PA, Black
Connector body	Plastic, TPU, Black/Translucent
Protective component	without protective circuitry
Seal	Plastic, TPU
Display switch state	LED, Yellow/Green
Mechanical lifespan	> 100 Mating cycles
Pollution degree	3
Protection class	IP65, IP67, IP68, (mounted)
Connector B	Male, M12 × 1, Straight
Number of pins	4+PE
Contacts	Metal, CuZn, Gold-plated
Contact carriers	Plastic, TPU, Black
Connector body	Plastic, TPU, Black
Coupling nut/retaining screw	Brass, CuZn, Nickel-plated
Tightening torque	0.8 ... 1 Nm
Mechanical life	> 100 Mating cycles
Pollution degree	3
Protection class	IP67, IP69K, Only when screwed together
Cable diameter	Ø 5.3 mm ±0.20
Cable length	1.5 m
Cable jacket	PVC, Black
Core insulation	PVC

### Contact assignment

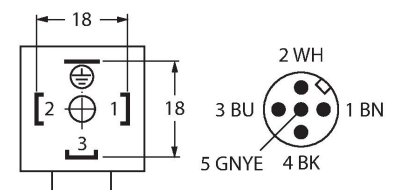

### Circuit Diagram

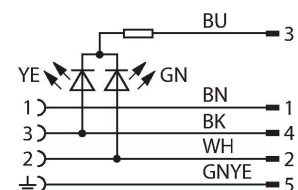

## Technical data

Core cross-section	4 x 0.34 mm <sup>2</sup>
Arrangement of strands	19 x 0.15 mm
Core colors	BN, WH, BU, BK, GNYE
<b>Electrical properties at +20 °C</b>	
Rated voltage	24 V
Test voltage	2000 V
Current	4 A
Insulation resistance	> 1 MΩ/km
Insulation resistance	≥ 10 <sup>8</sup> Ω
forward resistance	max. 57 Ω/km
<b>Mechanical and chemical properties</b>	
Bending radius (stationary installation)	≥ 5 x Ø
Bending radius (flexible use)	≥ 10 x Ø
Ambient temperature range (stationary)	-40 °C...+105 °C
Ambient temperature range (In motion)	0 °C...+80 °C
Mounting screw	Brass, CuZn, nickel-plated
Approvals	CE UKCA