

VBS02-A80E-5/TXL

Valve connector B type – Connection Cable

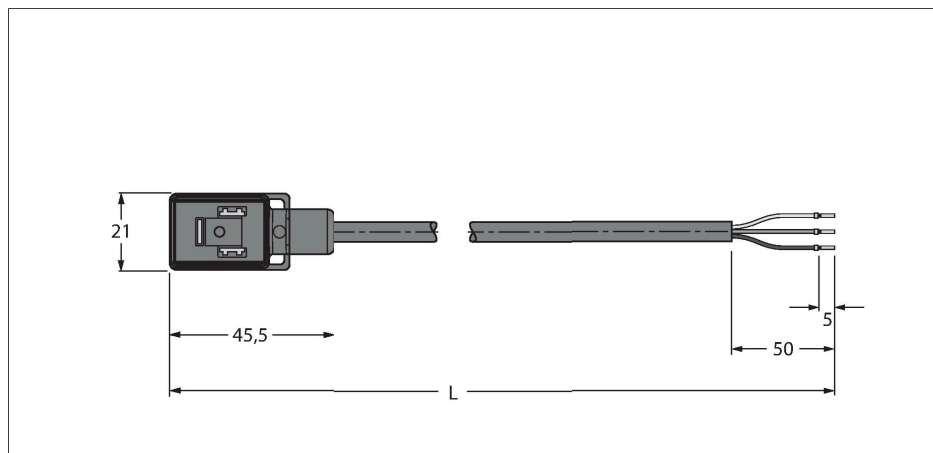

Features



- 2-pin + PE
- Design according to the DIN EN 175301-803
- RoHS-compliant
- Protection class: IP65, IP67, IP68
- Without protective circuitry
- Without LED
- Jacket material: PUR
- Jacket color: black
- Suitable for drag chain use
- Resistant to chemicals and oils
- UV and ozone resistance
- Flame retardant
- Free from halogen, silicone, PVC and LABS
- Cable length: 5.0 m

Technical data

Type	VBS02-A80E-5/TXL
ID	6606817
Connector A	Valve connector, Design B
Number of Pins	2+PE
Contacts	Metal, CuSn, Silver-plated
Contact carriers	Plastic, PA, Black
Connector body	Plastic, TPU, Black/Translucent
Protective component	without protective circuitry
Seal	Plastic, TPU
Mechanical lifespan	> 100 Mating cycles
Pollution degree	3
Protection class	IP65, IP67, IP68, (mounted)
Cable diameter	Ø 5.7 mm ±0.20
Cable length	5 m
Cable jacket	PUR, Black
Core insulation	PP
Core cross-section	3 x 0.75 mm ²
Arrangement of strands	42 x 0.15 mm
Core colors	BN, BU, GNYE
Electrical properties at +20 °C	
Rated voltage	230 V
Test voltage	2000 V
Current	4 A
Insulation resistance	> 1 MΩ/km
Insulation resistance forward resistance	≥ 10 ⁸ Ω
	max. 26 Ω/km

Contact assignment

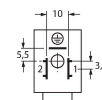

Circuit Diagram

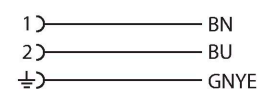

Technical data

Mechanical and chemical properties	
Max. tensile strength (static)	$\leq 50 \text{ N/mm}^2$
Max. tensile strength (dynamic)	$\leq 20 \text{ N/mm}^2$
Bending radius (stationary installation)	$\geq 5 \times \varnothing$
Bending radius (flexible use)	$\geq 10 \times \varnothing$
Bending cycles	$\geq 3 \text{ million}$
Admissible acceleration	max. 5 m/s^2
Admissible travel path, horizontal	5 m (at 5 m/s^2)
Admissible travel path, vertical	2 m (at 5 m/s^2)
Admissible traversing speed	3.3 m/s
Torsional stress	$\pm 180 \text{ }^\circ/\text{m}$
Ambient temperature range (stationary)	$-40 \text{ }^\circ\text{C} \dots +80 \text{ }^\circ\text{C}$
Ambient temperature range (In motion)	$-30 \text{ }^\circ\text{C} \dots +90 \text{ }^\circ\text{C}$
Ambient temperature during drag chain operation	$-25 \text{ }^\circ\text{C} \dots +60 \text{ }^\circ\text{C}$
Mounting screw	Brass, CuZn, nickel-plated