

FOUNDATION fieldbus IP67 junction box, 4-channel JBBS-49-E413/EX

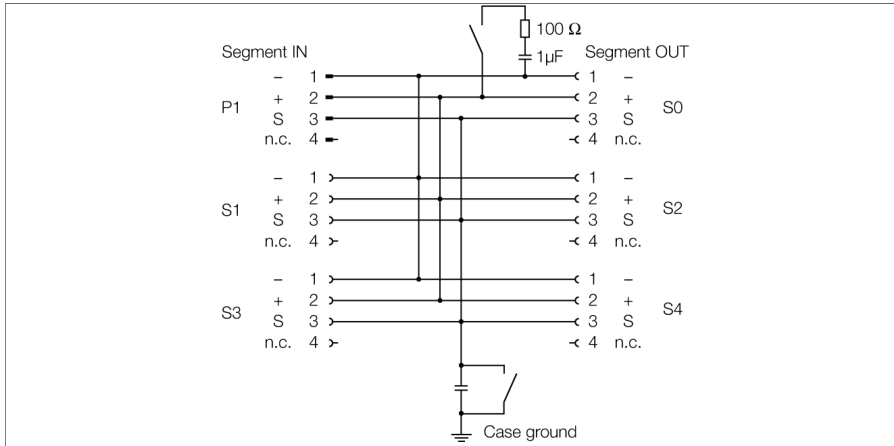

The 4-channel Ex junction box JBBS-49-E413/EX is designed for FOUNDATION™ fieldbus systems.

The housing is made of powder-coated die-cast aluminium and is IP67 rated.

The junction box is equipped with an activatable terminating resistor for the bus. The switch is integrated in the housing on the board.

Condensation in the housing is prevented by a breather.

Shielding and housing can be connected directly via a second switch which is also located on the board.

Note: It must be ensured that there is sufficient equipotential bonding in the system. The device is connected to the equipotential bonding via the housing's M5 x 1 grounding bolt.

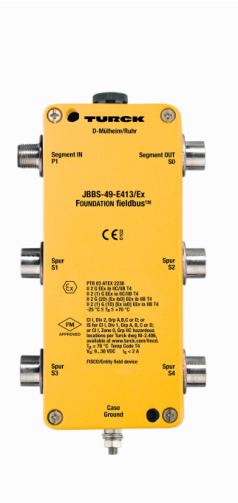

- Junction box for wall mounting with stainless steel M12 flange connections
- Integrated terminating resistor (activatable)
- Cable shielding: Capacitive or direct connection to housing potential selectable via switch
- Isolated support terminal for optional protective conductor incorporated in cable
- Powder-coated die-cast aluminium housing
- Pressure compensation element protects against condensation
- Connection of the housing potential via M5 x 1 bolt
- Entity and FISCO compliant according to IEC 60079-11

Type	JBBS-49-E413/EX
ID	6611425
Fieldbus standard	IEC 61158-2
Operating voltage	9...32 VDC
Ex approval acc. to conformity certificate	PTB 03 ATEX 2236
Device designation	Ⓢ II 2 G Ex ib IIC T4 Gb
Device marking	Ⓢ II 2 (1) G Ex ia [ia Ga] IIC T4 Gb
	Ⓢ II 2 (1D) G Ex ia [ia IIC Da] IIB T4 Gb
	Ⓢ II 2 (2D) G Ex ib [ib IIC Db] IIB T4 Gb
	FISCO / Entity field device
Entity Parameter	
Max. output voltage U_o	≤ 24 V
Max. output current I_o	≤ 250 mA
Max. output power P_o	≤ 2560 mW
Max. input voltage U_i	≤ 24 V
Max. input current I_i	≤ 250 mA
Max. input power P_i	≤ 2560 mW
FISCO parameter according to IEC 60079-11	
Max. output voltage U_o	≤ 17.5 V
Max. output current I_o	≤ 380 mA
Max. output power P_o	≤ 5320 mW
Max. input voltage U_i	≤ 17.5 V
Max. input current I_i	≤ 380 mA
Max. input power P_i	≤ 5320 mW
External inductance/capacitance L/C,	trunk (in/out): negligible / ≤ 5.00 nF per field circuit: negligible / ≤ 0.82 nF Σ Field circuits: negligible / ≤ 5.00 nF
Electrical connection	M12 receptacle
Segment IN	1 x M12 - male
Segment OUT	1 x M12 - female
Spur line	4 x M12 - female
Earthing bolt	M5 x 1
Protection class	IP67
MTTF	705 years acc. to SN 29500 (Ed. 99) 40 °C
Ambient temperature	-30...+70 °C
Housing material	Powder-coated die-cast aluminium
Housing color	Black/yellow
Dimensions	64 x 150 x 45 mm
Connection mode	Wall mounting

Dimensions

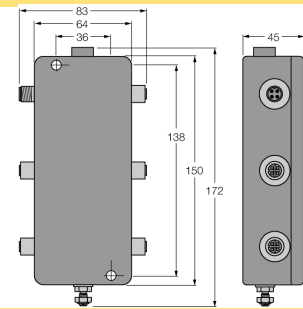

pin assignment

— M12 x 1

Segment in

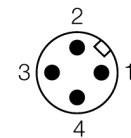

1 = V -
2 = V +
3 = shield
4 = n.c.

nominal values: 4 A, 300 V

⊖ M12 x 1

Segment out, Spur

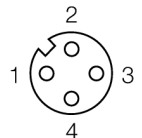

— M12 x 1

Segment in

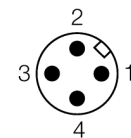

1 = V -
2 = V +
3 = shield
4 = n.c.

nominal values: 4 A, 300 V

⊖ M12 x 1

Segment out, Spur

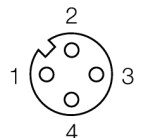

— 7/8"

Segment in

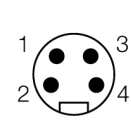

1 = V -
2 = V +
3 = shield
4 = n.c.

nominal values: 9 A, 300 V

⊖ 7/8"

Segment out, Spur

