

TB-4M12-5-5/TXL

Passive Actuator/Sensor Box, M12 × 1 – With Homerun Cable, 4-port

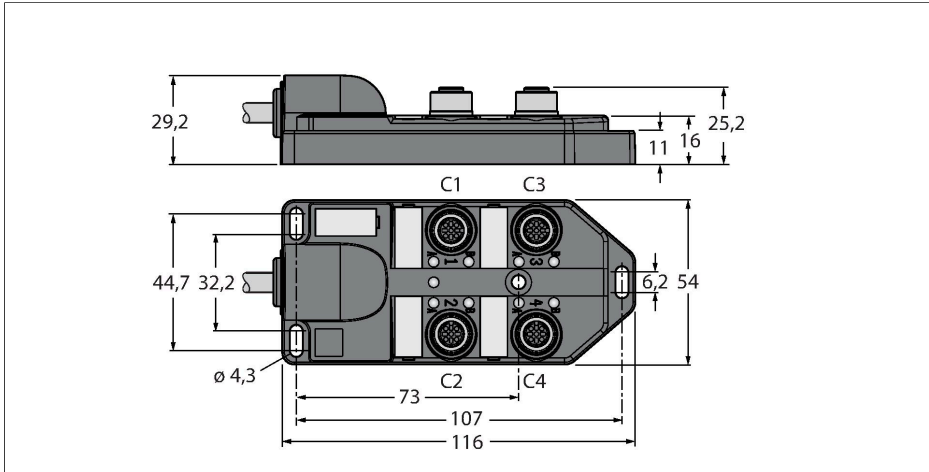

Features



- Housing material: Nylon
- Housing color: black
- Protection class IP67
- RoHS-compliant
- CE compliant
- I/O port (number of pins): 4-pin + PE

Technical data

Type	TB-4M12-5-5/TXL
ID no.	6611908
Distributed I/O	4, with integral homerun cable
Housing	Plastic, PA, Black
I/O port	M12 x 1
Number of Pins	4+PE
Contacts	Brass, CuZn, Gold-plated
Contact carriers	Plastic, PA, Black
Seal	Plastic, FPM/FKM
Mechanical lifespan	> 100 Mating cycles
Group terminal	Cable
Cable diameter	Ø 8.38 mm
Cable length	5 m
Cable jacket	PUR, Black
Core insulation	PVC
Core cross-section	8 x 0.32 mm ²
Cable conductor cross-section	3x 0.82 mm ²
Core colors	GY, RD/BU, GN, GY/PK, WH/GN, BN/GN, WH, YE
Core colors	BN, BU, GNYE
Electrical properties at +20 °C	
Rated voltage	30 V
Current	2 A per signal contact, total current 9 A
Insulation resistance	≥ 10 ⁸ Ω
forward resistance	≤ 5 mΩ

Contact assignment

I/O Connector



Circuit Diagram

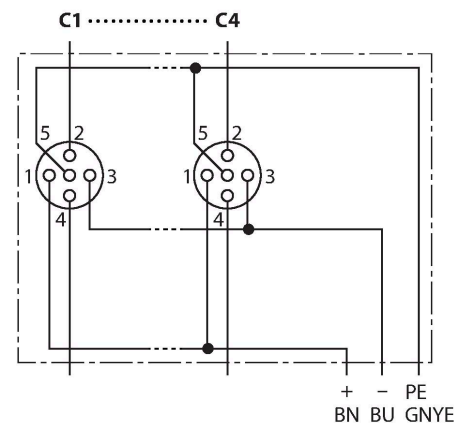

Technical data

Mechanical and chemical properties

Bending radius (stationary installation)	≥ 5 x Ø
Bending radius (flexible use)	≥ 15 x Ø
Ambient temperature range (stationary)	-40 °C...+85 °C

Wiring

Port/Pin	C1/2	C1/4	C2/2	C2/4	C3/2	C3/4	C4/2	C4/4
M23 flange	7	15	4	5	8	16	14	3
Cable	GYPK	WH	RDBU	GN	WHGN	YE	BNGN	GY

Power C1-C8	24 V	0 V	PE
M23 flange	19	6	12
Cable	BN	BU	GNYE

Scope of delivery

Device	Quantity	Description
Junction boxes	1	Passive actuator/sensor junction box
VS-M12-BK	2	Closure caps for M12 female connectors
KS9/20	5	Labels

Accessories

Ident-No.	Designation	Description
6900196	CK19-0	Field-wireable female M23, 19-pin, straight
6930225	CS19-0	Field-wireable male M23, 19-pin, straight
6625616	RKC5T-2-RSC5T/ TXL	Actuator/sensor cable, female M12 - male M12, straight, 5-pin, 2 m *
6936055	VS-M12-BK	Closure caps for M12 female connectors
8015002	KS9/20	Labels

* Other lengths available on request