

WSS8T-10/TEL

Actuator and Sensor Cable, PVC – Connection Cable

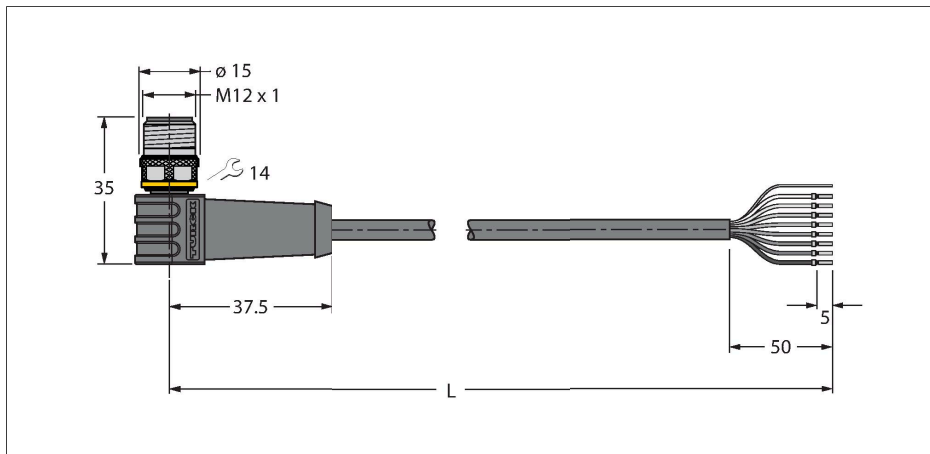

Features



- Male M12, angled, 8-pin
- Shield on coupling nut/screw
- Jacket material: PVC, shielded
- Jacket color: black
- Resistant to chemicals and oils
- Flame retardant
- Resistant to acids and alkaline solutions
- Resistant to microbes and hydrolysis
- LABS free
- Protection class: IP67, IP69K
- Cable length: 10 m

Technical data

Type	WSS8T-10/TEL
ID	6625457
Connector A	Male, M12 × 1, Angled, A-coded
Number of Pins	8
Contacts	Brass, CuZn, Gold-plated
Contact carriers	Plastic, TPU, Black
Connector body	Plastic, TPU, Black
Coupling nut/screw	Brass, CuZn, Nickel-plated
Mechanical lifespan	> 100 Mating cycles
Pollution degree	3
Protection class	IP67, IP69K, Only in screwed condition
Cable	
Cable diameter	Ø 6.4 mm ±0.20
Cable length	10 m
Cable jacket	PVC, Black
Shielding	Aluminum foil, tinned copper wire
Core insulation	PVC
Core cross-section	8 x 0.25 mm ²
Arrangement of strands	32 x 0.1 mm
Core colors	BN, WH, BU, BK, GY, PK, VT, OG
Electrical properties at +20 °C	
Rated voltage	30 V
Test voltage	2000 V
Current	2 A
Insulation resistance	> 30.5 MΩ/km
forward resistance	max. 79 Ω/km

Cable Cross-Section

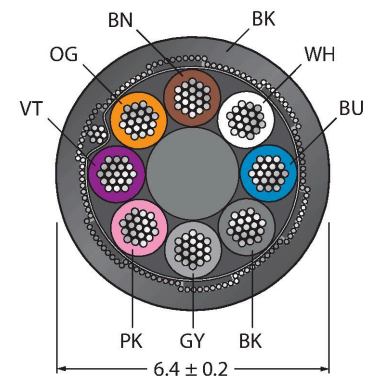

Contact assignment

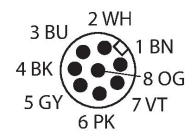

Functional principle

Drawing shows design status including hexagon coupling nut (Production start CW11/2016). Wiring diagram shows contact assignment acc. to DIN EN 60947-5-2 (Production start CW16/2017).

Technical data

Mechanical and chemical properties

Bending radius (stationary installation)	$\geq 5 \times \varnothing$
Bending radius (flexible use)	$\geq 10 \times \varnothing$
Ambient temperature range (stationary)	-40 °C...+105 °C
Ambient temperature range (In motion)	0 °C...+80 °C
Approvals	cULus

Circuit Diagram

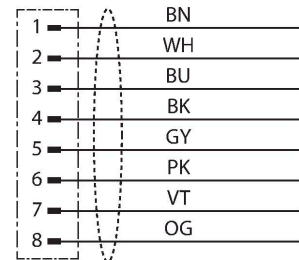

Stranded Wire Colors

Pin	DIN 47100 (old)	DIN EN 60947-5-2 (new)
1	WH	BN
2	BN	WH
3	GN	BU
4	YE	BK
5	GY	GY
6	PK	PK
7	BU	VT
8	RD	OG

Accessories

CMB8181-0

6931450

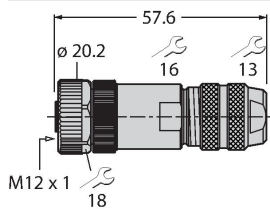

Field-wireable female connector, M12 × 1, straight, 8-pin, screw terminal connection, cable feedthrough 6.0 to 8.0 mm, core cross-section/terminal capacity 0.14 to 0.50 mm², metal housing, metal nut, shieldable

CMB8281-0

6932024

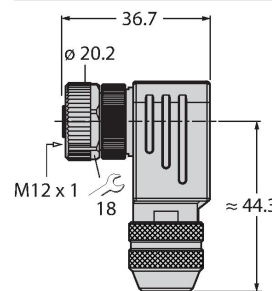

Field-wireable female connector, M12 × 1, angled, 8-pin, screw terminal connection, cable feedthrough 6.0 to 8.0 mm, core cross-section/terminal capacity 0.14 to 0.50 mm², metal housing, metal nut, shieldable

TORQUE-WRENCH-SET-AS

6936170



Torque wrench set; handles with adjustable torque 0.4-1.0 Nm, torque wrench for M8 (SW9), fork wrench for M12 (SW 14)

BLANK-LABEL-FOR-CORDSETS-TEL-TXL

6936206

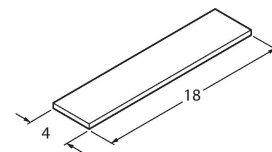

Label for TEL and TXL cables, length: 18 mm, height: 4 mm, material: polycarbonate (PC), color: white, halogen-free and flame-retardant