

# RFID Cable Standard Version Extension Cable WK4.5T-10-RS4.5T/S2500

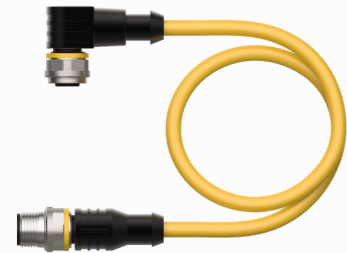
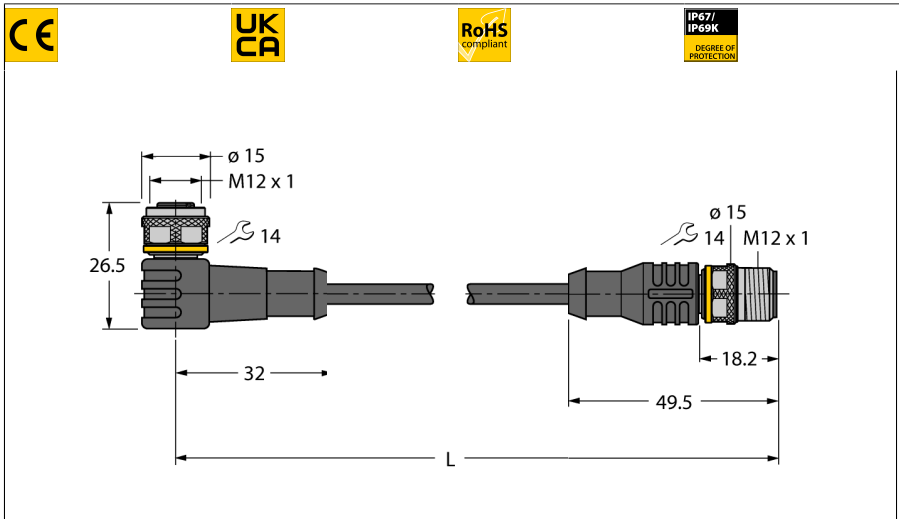

- 4-wire, AWG 24/AWG 22
- Jacket material: PUR, color: yellow
- Free from halogen and LABS
- Shielding: Aluminum foil, tinned copper braid
- Jacket diameter: 6.9 mm
- Suitable for drag chain use, oil resistant, highly flexible
- Cable UL Style 20594
- Cable length: 10 m

Type	WK4.5T-10-RS4.5T/S2500
ID	6699205
Connector A	Female, M12 × 1, Angled, A-coded
Number of Pins	5
Contact carriers	Plastic, TPU, Black
Connector body	Plastic, TPU, Black
Coupling nut/screw	Brass, CuZn-Ni, Nickel-plated
Tightening torque (range)	0.6 ... 1 Nm (observe max. torque of mating connector!)
Mechanical lifespan	> 100 Mating cycles
Pollution degree	3
Protection class	IP67, IP69K, Only in screwed condition

Connector B	Male, M12 × 1, Straight, A-coded
Number of pins	5 pins
Contact carriers	Plastic, TPU, Black
Connector body	Plastic, TPU, Black
Coupling nut/retaining screw	Brass, CuZn-Ni, Nickel-plated
Tightening torque	0.6 ... 1 Nm (observe max. torque of mating connector!)
Mechanical life	> 100 Mating cycles
Pollution degree	3
Protection class	IP67, IP69K, Only when screwed together

Cable	
Cable diameter	Ø 6.9mm
Cable length	10 m m
Cable jacket	PUR, Yellow
Shielding	yes
Data cable cores	
Core cross-section	2 x 0.25 mm <sup>2</sup>
Power cable cores	
Core cross-section	2x 0.34 mm <sup>2</sup>
Core colors	Power: BN, BU Data: WH, BK



### Circuit Diagram

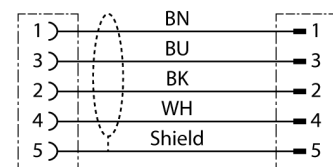

Electrical properties at +20 °C	
Rated voltage	30VV
Current	4AA
DC resistance (loop)	103 Ω/km
Nom. impedance	135 Ω
Nom. capacitance	50 pF/m
Mechanical and chemical properties	
Bending radius (flexible use)	≥ 8 x Ø
Bending cycles	≥ 1 million
Ambient temperature range (stationary)	-40°C...+80°C
Ambient temperature range (In motion)	-25°C...+80°C
Other Features	
Qualified for drag chain use	yes
Halogen-free	yes