

EC-FSE4-L/16

– female flange with solder contacts, front-mounted

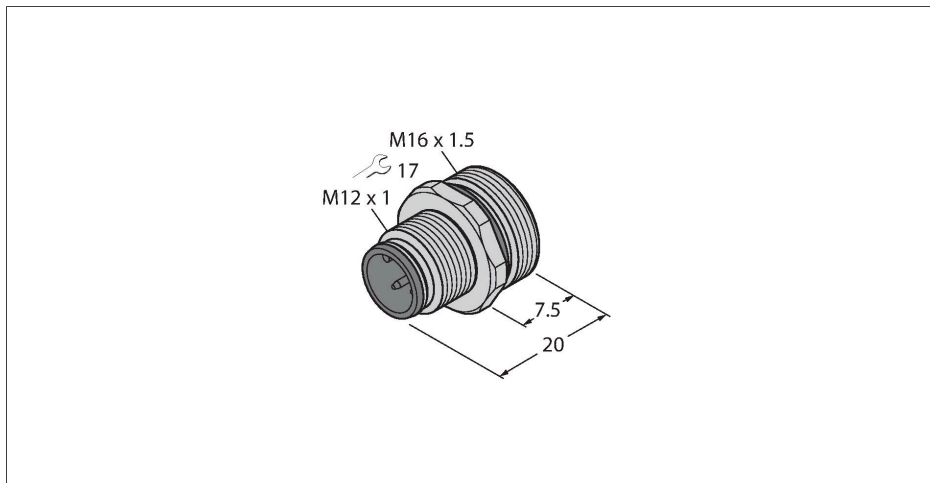

Features



- M12 × 1 male receptacle
- Protection class IP67
- Stainless steel receptacle housing
- Front panel mounting
- Connected via solder contacts

Contact assignment

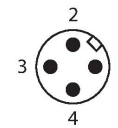

Technical data

Type	EC-FSE4-L/16
ID	6934066
Connector A	Male, M12 × 1, Straight, A-coded
Number of Pins	4
Contacts	Brass, CuZn, Gold-plated
Contact carriers	Plastic, PA GF, Black
Flange housing	Stainless Steel, 1.4404 (AISI 316L)
Mounting type	front panel mounting
Screw-in thread seal	plastic, NBR
Screw-in thread	M16 × 1.5
Connection mode	Solder contact
Mechanical lifespan	> 100 Mating cycles
Pollution degree	3
Protection class	IP67, (screwed together)
Electrical properties at +20 °C	
Rated voltage	250 V
Current	4 A
Insulation resistance	≥ 10 ⁸ Ω
forward resistance	≤ 5 mΩ
Mechanical and chemical properties	
Ambient temperature range (stationary)	-30 °C...+90 °C
Approvals	CE