

# EC-FSFD4-P/16

– male flange with print contacts, rear-mounted

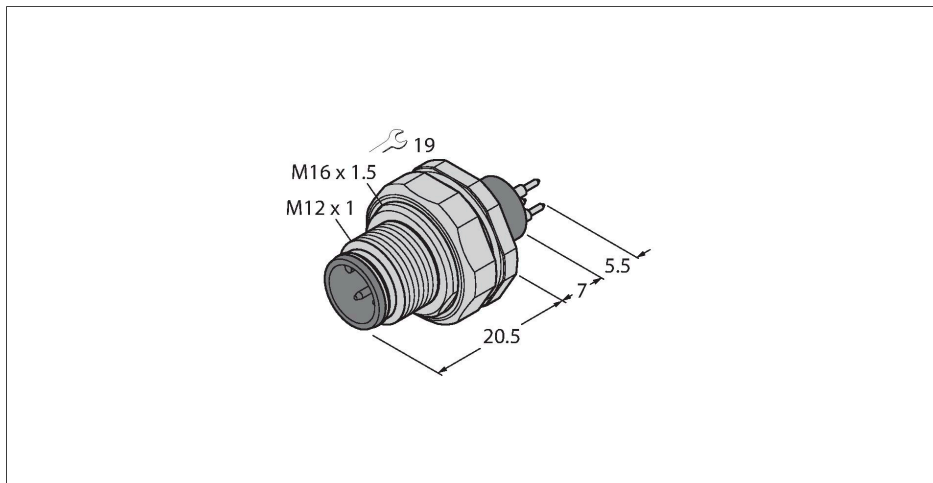

## Features



- M12 × 1 male receptacle
- Protection class IP67
- Rear-mounted
- Connected via print contacts

## Contact assignment

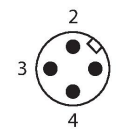

## Technical data

Type	EC-FSFD4-P/16
ID	6934584
Connector A	Male, M12 × 1, Straight, A-coded
Number of Pins	4
Contacts	Brass, CuZn, Gold-plated
Contact carriers	Plastic, PA GF, Black
Flange housing	Brass, CuZn, Nickel-plated
Mounting type	backplane mounting
Screw-in thread seal	plastic, NBR
Screw-in thread	M16 × 1.5
Connection mode	Print contact
Mechanical lifespan	> 100 Mating cycles
Pollution degree	3
Protection class	IP67, (screwed together)
<b>Electrical properties at +20 °C</b>	
Rated voltage	250 V
Current	4 A
Insulation resistance	≥ 10 <sup>8</sup> Ω
forward resistance	≤ 5 mΩ
<b>Mechanical and chemical properties</b>	
Ambient temperature range (stationary)	-30 °C...+90 °C
Approvals	CE