

EC-FS8-L/16

– female flange with solder contacts, front-mounted

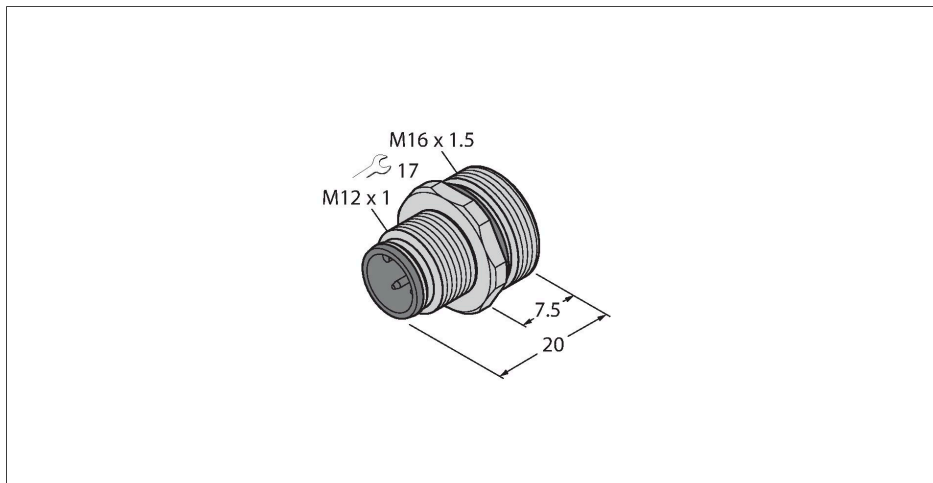

Features



- M12 × 1 male receptacle
- Protection class IP67
- Front panel mounting
- Connected via solder contacts

Contact assignment

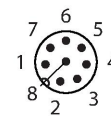

Technical data

Type	EC-FS8-L/16
ID	6934641
Connector A	Male, M12 × 1, Straight, A-coded
Number of Pins	8
Contacts	Brass, CuZn, Gold-plated
Contact carriers	Plastic, PA GF, Black
Flange housing	Brass, CuZn, Nickel-plated
Mounting type	front panel mounting
Screw-in thread seal	plastic, NBR
Screw-in thread	M16 × 1.5
Connection mode	Solder contact
Mechanical lifespan	> 100 Mating cycles
Pollution degree	3
Protection class	IP67, (screwed together)
Electrical properties at +20 °C	
Rated voltage	30 V
Current	2 A
Insulation resistance	≥ 10 ⁸ Ω
forward resistance	≤ 5 mΩ
Mechanical and chemical properties	
Ambient temperature range (stationary)	-30 °C...+90 °C
Approvals	CE