

EC-FK5-0.5/20

– female flange with strands, front-mounted

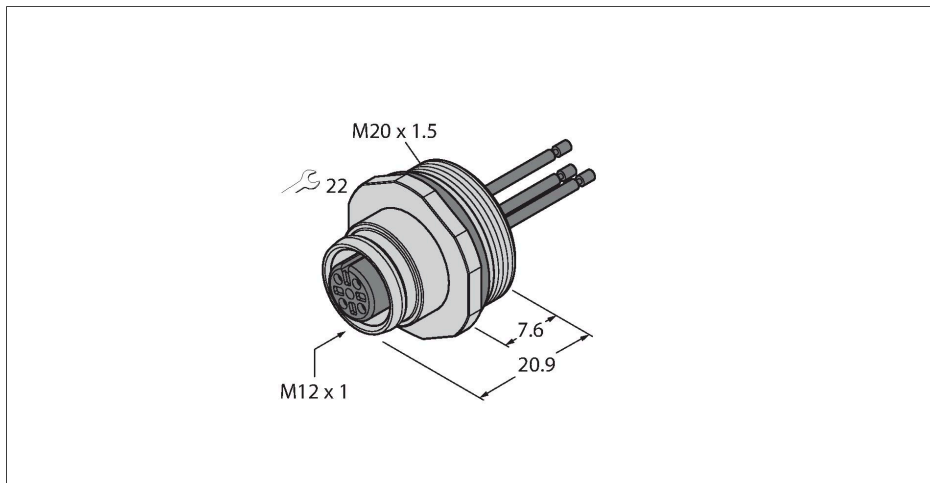

Features



- M12 × 1 female receptacle
- Protection class IP67
- Front panel mounting
- Connected via stranded wires

Contact assignment

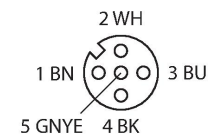

Technical data

Type	EC-FK5-0.5/20
ID	6935741
Connector A	Female, M12 × 1, Straight, A-coded
Number of Pins	4+PE
Contacts	Brass, CuZn, Gold-plated
Contact carriers	Plastic, TPU, Black
Seal	Plastic, FPM/FKM
Flange housing	Brass, CuZn, Nickel-plated
Mounting type	front panel mounting
Screw-in thread seal	plastic, NBR
Screw-in thread	M20 × 1.5
Connection mode	Wire connection
Mechanical lifespan	> 100 Mating cycles
Pollution degree	3
Protection class	IP67, (screwed together)
Cable length	0.5 m
Core insulation	PVC
Core cross-section	4 x 0.34 mm ²
Core colors	BN, WH, BU, BK, GNYE
Electrical properties at +20 °C	
Rated voltage	60 V
Current	4 A
Insulation resistance	≥ 10 ⁸ Ω
forward resistance	≤ 5 mΩ
Mechanical and chemical properties	
Ambient temperature range (stationary)	-30 °C...+90 °C



Technical data

Approvals

CE
