

BKM14-E01-50/S90

Actuator and sensor cable – Connection Cable

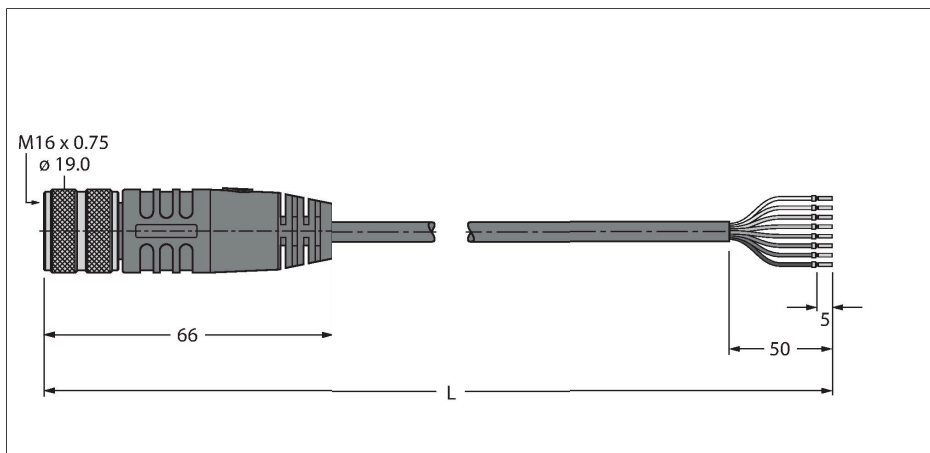

Features



- M16 connector, female, straight, 14-pin
- Sheath material: TPU
- Sheath color: black
- Flame-retardant (FT1)
- Approval: UL and CSA
- RoHS-compliant
- Protection class IP67
- Cable length: 50 m

Technical data

Type	BKM14-E01-50/S90
ID	6936406
Connector A	Female, M16 × 0.75, Straight
Number of Pins	14
Contacts	Brass, CuZn, Gold-plated
Contact carriers	Plastic, TPU, Black
Connector body	Plastic, TPU, Black
Coupling nut/screw	Brass, CuZn, Nickel-plated
Seal	Plastic, FPM/FKM
Mechanical lifespan	> 100 Mating cycles
Pollution degree	3
Protection class	IP67
Cable	
Network protocol	S90
Cable diameter	Ø 6.9 mm ±0.15
Cable length	50 m
Cable jacket	TPU, Black
Shielding	no
Core insulation	PVC
Core cross-section	2 x 0.52 mm ²
Arrangement of strands	19 x 0.19 mm
Core cross-section	8x 0.21 mm ²
Litz wire arrangement	19 x 0.13 mm
Core colors	BN, BK, PK, GN, BU, VT, WH, RD, GY, YE
Electrical properties at +20 °C	
Rated voltage	300 V

Contact assignment

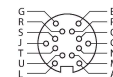

Circuit Diagram

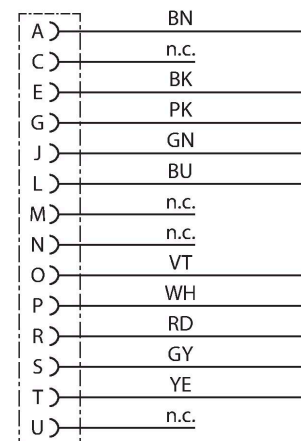

Technical data

Current 3 A

Mechanical and chemical properties

Bending radius (stationary installation) $\geq 5 \times \varnothing$

Bending radius (flexible use) $\geq 10 \times \varnothing$

Ambient temperature range (stationary) $-40 \text{ °C} \dots +90 \text{ °C}$
