

# HT-WWAK4-5-HT-WWAS4/S2430

## High-Temperature Resistant Actuator and Sensor Cable – Extension Cable

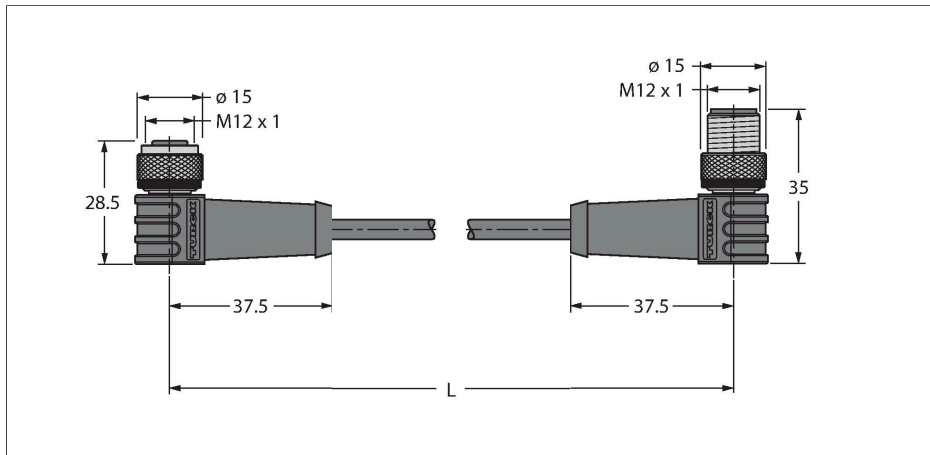

### Features



- M12 female connector, angled, 4-pin
- M12 male connector, angled, 4-pin
- Sheath material: PTFE
- Sheath color: white
- Flame-retardant
- Resistant to welding sparks
- Resistant to chemicals, UV radiation and oils
- Resistant to acids and alkaline solutions
- LABS free
- Resistant to microbes and hydrolysis
- Cold and heat-flexible
- RoHS-compliant
- Protection class IP65
- Temperature range of the cable: -190°C... 260°C
- Cable length: 5.0 m

### Cable Cross-Section

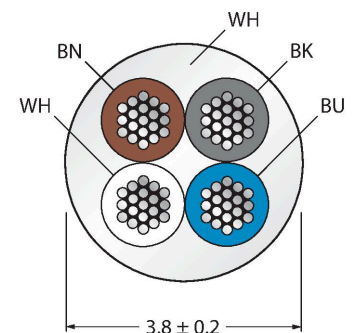

### Contact assignment



### Technical data

Type	HT-WWAK4-5-HT-WWAS4/S2430
ID	8039137
Connector A	Female, M12 × 1, Angled
Number of Pins	4
Contacts	Brass, CuZn, Gold-plated
Contact carriers	Plastic, PBT GF, Black
Connector body	Plastic, PBT GF, Black
Coupling nut/screw	Brass, CuZn, Nickel-plated
Seal	Plastic, FPM/FKM
Tightening torque (range)	0.8 ... 1 Nm (observe max. torque of mating connector!)
Mechanical lifespan	> 100 Mating cycles
Pollution degree	3
Protection class	IP65, Only in screwed condition
Connector B	Male, M12 × 1, Angled
Number of pins	4
Contacts	Brass, CuZn, Gold-plated
Contact carriers	Plastic, PBT GF, Black
Connector body	Plastic, PBT GF, Black
Coupling nut/retaining screw	Brass, CuZn, Nickel-plated
Tightening torque	0.8 ... 1 Nm (observe max. torque of mating connector!)
Mechanical life	> 100 Mating cycles
Pollution degree	3
Protection class	IP65, Only when screwed together

## Technical data

Cable	
Cable diameter	Ø 3.8 mm ±0.20
Cable length	5 m
Cable jacket	PTFE, White
Core insulation	PTFE
Core cross-section	4 x 0.34 mm <sup>2</sup>
Arrangement of strands	7 x 0.254 mm
Core colors	BN, WH, BU, BK
Electrical properties at +20 °C	
Rated voltage	250 V
Current	4 A
Insulation resistance	≥ 10 <sup>8</sup> Ω
forward resistance	≤ 5 mΩ
Mechanical and chemical properties	
Bending radius (stationary installation)	≥ 5 x Ø
Bending radius (flexible use)	≥ 10 x Ø
Ambient temperature range (stationary)	-20 °C...+150 °C

## Circuit Diagram

