

HT-WAS4-2/S2430

High-Temperature Resistant Actuator and Sensor Cable – Connection Cable

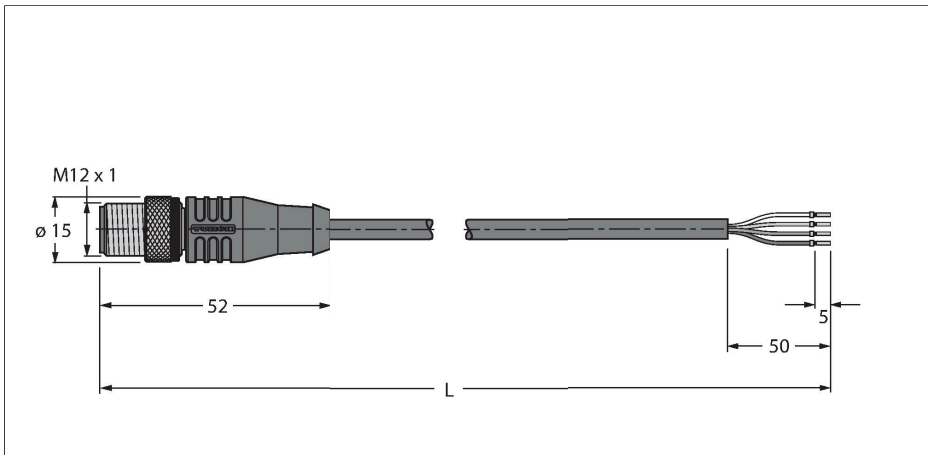

Features



- M12 male connector, straight, 4-pin
- Sheath material: PTFE
- Sheath color: white
- Flame-retardant
- Resistant to welding sparks
- Resistant to chemicals, UV radiation and oils
- Resistant to acids and alkaline solutions
- LABS free
- Resistant to microbes and hydrolysis
- Cold and heat-flexible
- RoHS-compliant
- Protection class IP65
- Temperature range of the cable: -190°C... 260°C
- Cable length: 2.0 m

Cable Cross-Section

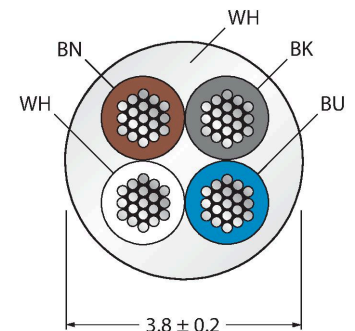

Contact assignment

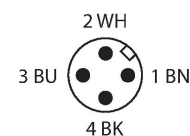

Technical data

Type	HT-WAS4-2/S2430
ID	8039233
Connector A	Male, M12 × 1, Straight
Number of Pins	4
Contacts	Brass, CuZn, Gold-plated
Contact carriers	Plastic, PBT GF, Black
Connector body	Plastic, PBT GF, Black
Coupling nut/screw	Brass, CuZn, Nickel-plated
Seal	FPM/FKM
Tightening torque (range)	0.8 ... 1 Nm (observe max. torque of mating connector!)
Mechanical lifespan	> 100 Mating cycles
Pollution degree	3
Protection class	IP65, Only in screwed condition
Cable	
Cable diameter	Ø 3.8 mm ±0.20
Cable length	2 m
Cable jacket	PTFE, White
Core insulation	PTFE
Core cross-section	4 x 0.34 mm ²
Arrangement of strands	7 x 0.254 mm
Core colors	BN, WH, BU, BK
Electrical properties at +20 °C	
Rated voltage	250 V
Current	4 A
Insulation resistance	≥ 10 ⁸ Ω

Technical data

forward resistance $\leq 5 \text{ m}\Omega$

Mechanical and chemical properties

Bending radius (stationary installation) $\geq 5 \times \varnothing$

Bending radius (flexible use) $\geq 10 \times \varnothing$

Ambient temperature range (stationary) $-20 \text{ }^\circ\text{C} \dots +150 \text{ }^\circ\text{C}$

Circuit Diagram

