

# DT06-2S-A-10-RSC4.221T/TXL

## Deutsch Connector – Extension Cable

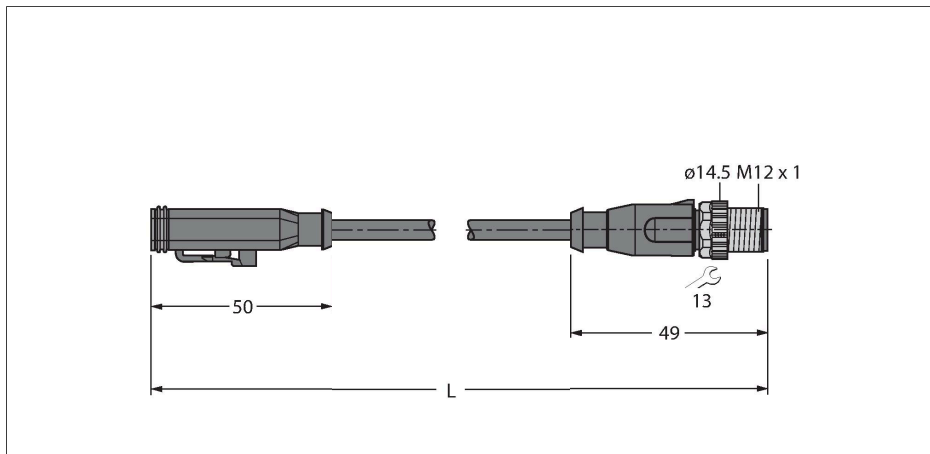

### Features

- Deutsch connector DT06, straight, 2-pin
- Jacket material: TPE-U (PUR)
- Jacket color: black, similar to RAL 9005
- Qualified for drag chain use
- Flame-retardant acc. to cULus 20549
- Halogen-free acc. DIN VDE 0472 part 815
- Approval: cULus
- RoHS-compliant
- Protection classes IP67/IP69K
- Cable length: 10 m

### Contact assignment

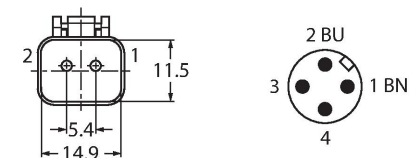

### Circuit Diagram

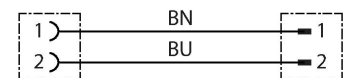

### Technical data

Type	DT06-2S-A-10-RSC4.221T/TXL
ID	100002060
Connector A	Female, Deutsch DT, Straight
Number of Pins	2
Contacts	Brass, CuZn, Gold-plated
Contact carriers	Plastic, TPU, Black
Connector body	Plastic, TPU, Black
Seal	Plastic, Silicone
Mechanical lifespan	> 100 Mating cycles
Pollution degree	3
Protection class	IP67, (plugged)
Connector B	Male, M12 × 1, Straight
Contacts	Brass, CuZn, Gold-plated
Contact carriers	Plastic, TPU, Black
Connector body	Plastic, TPU, Black
Coupling nut/retaining screw	Brass, CuZn, Nickel-plated
Tightening torque	0.8 ... 1 Nm (observe max. torque of mating connector!)
Mechanical life	> 100 Mating cycles
Pollution degree	3
Protection class	IP67, Only when screwed together
Cable	
Cable diameter	Ø 5 mm ±0.15
Cable length	10 m
Cable jacket	PUR, Black
Core insulation	PP
Core cross-section	2 x 0.75 mm <sup>2</sup>

## Technical data

Arrangement of strands	42 x 0.15 mm
Core colors	BN, BU
<b>Electrical properties at +20 °C</b>	
Rated voltage	230 V
Test voltage	3000 V
Current	4 A
<b>Mechanical and chemical properties</b>	
Bending radius (stationary installation)	≥ 5 x Ø
Bending radius (flexible use)	≥ 10 x Ø
Bending cycles	≥ 4 million
Admissible acceleration	max. 10 m/s <sup>2</sup>
Admissible traversing speed	3.33 m/s
Ambient temperature range (stationary)	-40 °C...+80 °C
Ambient temperature range (In motion)	-25 °C...+80 °C