

FSFD46PS-1/M16

M12 Power Flange – Rear-mounted

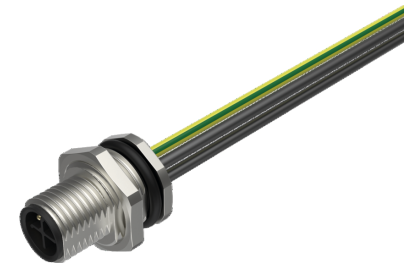
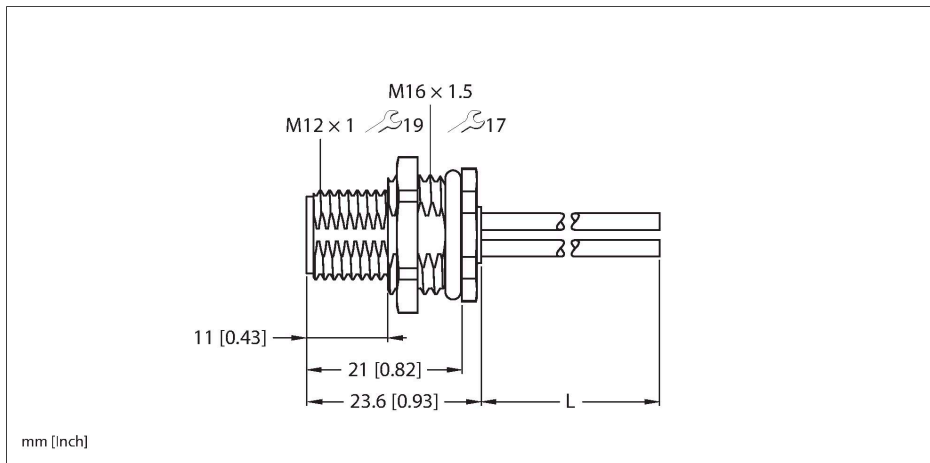

Technical data

Type	FSFD46PS-1/M16
ID	U2-28504
Connector A	Male, M12 × 1, S-coded
Design specification	acc. to IEC 61076-2-111
Number of Pins	3+PE
Contacts	Brass, CuZn, Gold-plated
Contact carriers	Plastic, PA, Black
Seal	Plastic
Flange housing	Brass, CuZn, Nickel-plated
Tightening torque (range)	0.4 ... 1 Nm (observe max. torque of mating connector!)
Mounting type	backplane mounting
Screw-in thread seal	O-ring, NBR
Screw-in thread	M16 × 1.5 BrassCuZnNickel-plated
Flange tightening torque	2.5...7.3 Nm
Mechanical lifespan	> 100 Mating cycles
Pollution degree	3
Protection class	IP68 NEMA: 1, 3, 4, 6P
Conductor data	
Number of cores	4
Cable length	1 m, 1 m, (+ 50 mm or 4 % of the length/-0.0, depending on which value is larger)
Conductor material	TC (tinned copper)
Core insulation	PVC

Features



- M12 powerfast Flanschstecker
- M12-Stecker, S-codiert, 3-polig + PE

Contact assignment

Connector A

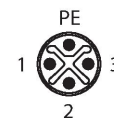

Circuit Diagram



Technical data

Core cross-section	4 x 16 AWG [Similar to 1.50 mm ²]
Core colors	BK1, BK2, BK3, GNYE
Electrical properties at +20 °C	
Rated voltage	630 V
Current	12 A
Mechanical and chemical properties	
Ambient temperature range (stationary)	-40 °C...+85 °C
Approvals	CE UKCA
Note	
<p>CAUTION: RISK OF ELECTRIC SHOCK! DO NOT DISCONNECT UNDER LOAD!</p> <p>- We reserve the right to make technical modifications without prior notice.</p>	

Through bore

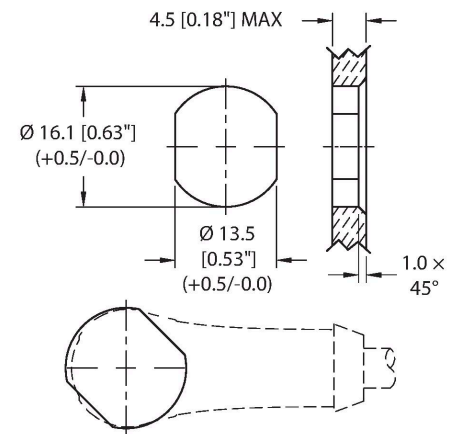

Threaded bore

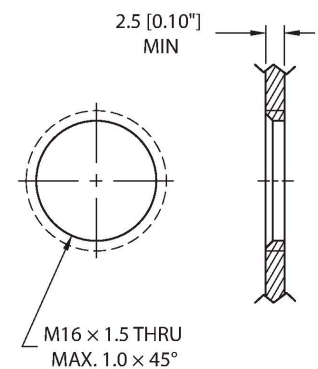

Rear-mounted

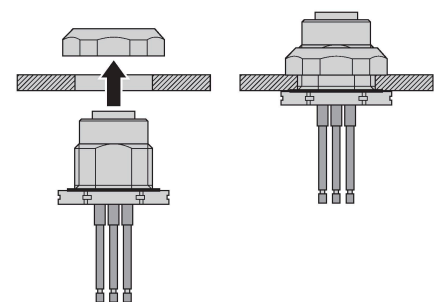

Derating curve

