

FK46PS-2/M16

M12 Power Flange – Front-mounted

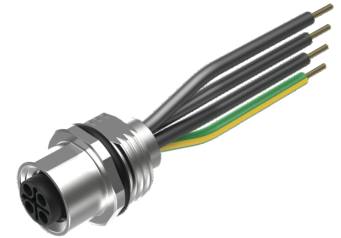

Features

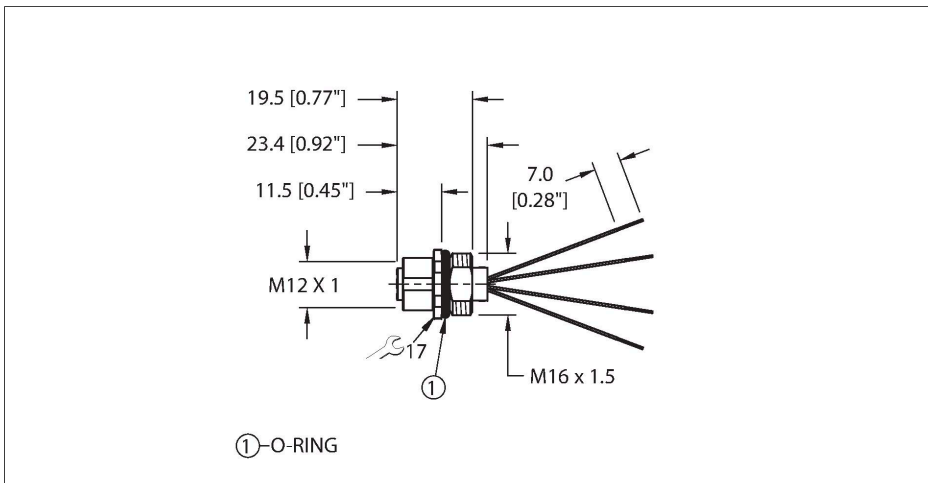

- M12 powerfast Flanschkupplung
- M12-Kupplung, S-codiert, 3-polig + PE

Contact assignment

Connector A

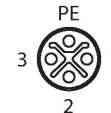

Circuit Diagram



Technical data

Type	FK46PS-2/M16
ID	U2-29265
Connector A	Female, M12 × 1, S-coded
Design specification	acc. to IEC 61076-2-111
Number of Pins	3+PE
Contacts	Brass, CuZn, Gold-plated
Contact carriers	Plastic, PA, Black
Seal	O ring, Plastic, FKM/FPM
Flange housing	Brass, CuZn, Nickel-plated
Tightening torque (range)	0.4 ... 1 Nm (observe max. torque of mating connector!)
Mounting type	front panel mounting
Screw-in thread seal	O-ring, NBR
Screw-in thread	M16 × 1.5
Flange tightening torque	2.5...7.3 Nm
Mechanical lifespan	> 100 Mating cycles
Pollution degree	3
Protection class	IP68
	NEMA: 1, 3, 4, 6P
Conductor data	
Number of cores	4
Cable length	2 m, 2 m, (+ 50 mm or 4 % of the length/-0.0, depending on which value is larger)
Conductor material	TC (tinned copper)
Core insulation	PVC
Core cross-section	4 x 16 AWG [Similar to 1.50 mm ²]

Technical data

Core colors	BK1, BK2, BK3, GNYE
Electrical properties at +20 °C	
Rated voltage	630 V
Current	12 A
Mechanical and chemical properties	
Ambient temperature range (stationary)	-40 °C...+85 °C
Approvals	CE UKCA
Note	
<p>CAUTION: RISK OF ELECTRIC SHOCK! DO NOT DISCONNECT UNDER LOAD!</p> <p>- The standard right-angled connection cable runs perpendicular to the flat surfaces of the mounting hole.</p> <p>- We reserve the right to make technical modifications without prior notice.</p>	

Through bore

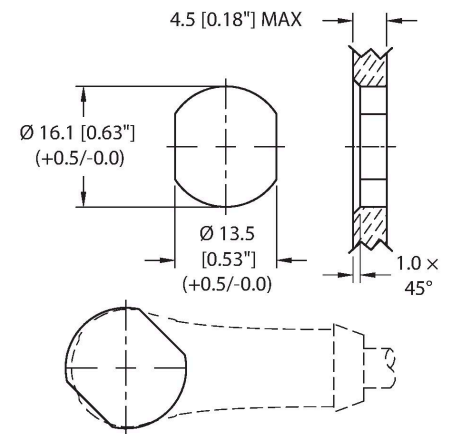

Threaded bore

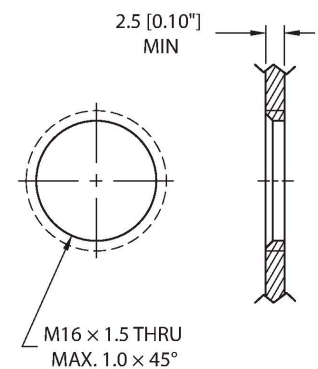

Front panel mounting

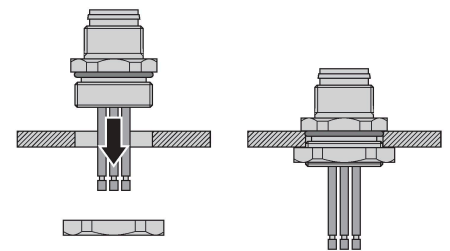

Derating curve

